

Niloe™
TV/SAT - TV/R/SAT passthrough and terminal sockets

Cat. Nos : 7 645 57/58/64/65

7 646 57/58/64/65

7 647 57/58/64/65

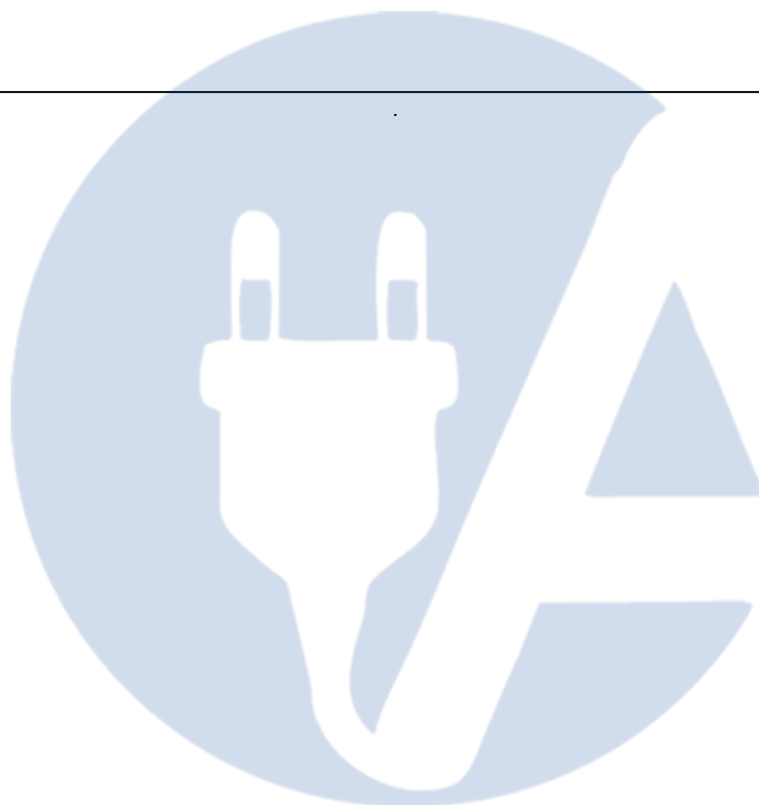
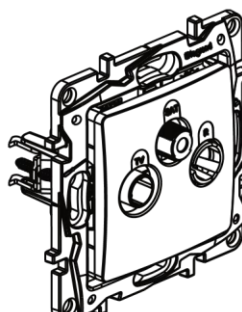
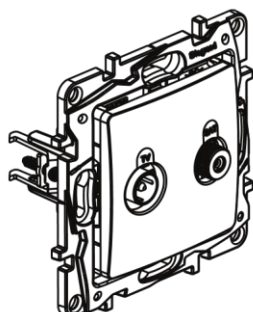

1. USE

TV/SAT: For receiving TV and satellite signals
 TV/R/SAT: For receiving TV, radio and satellite signals
 UHD compatible
 Class A shielding - Tap-off wiring
 Recommended cable 17/19 VATC

2. RANGE

Item	Colour			No. of modules
	Ivory	White	Brown	
14 dB TV/R/SAT passthrough socket	7 646 64	7 645 64	7 647 64	2
10 dB TV/R/SAT terminal socket	7 646 65	7 645 65	7 647 65	
14 dB TV/SAT passthrough socket	7 646 57	7 645 57	7 647 57	2
10 dB TV/SAT terminal socket	7 646 58	7 645 58	7 647 58	

3. DIMENSIONS (mm)

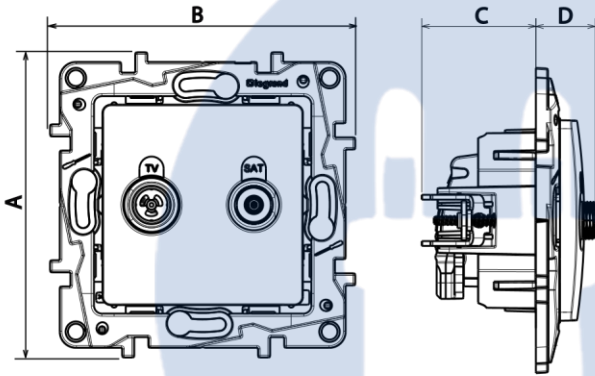

Cat. Nos	A	B	C	D
7 645 64/65 - 7 646 64/65 - 7 647 64/65	75,8	75,8	28,3	14,8
7 645 57/58 - 7 646 57/58 - 7 647 57/58				

4. CONNECTION

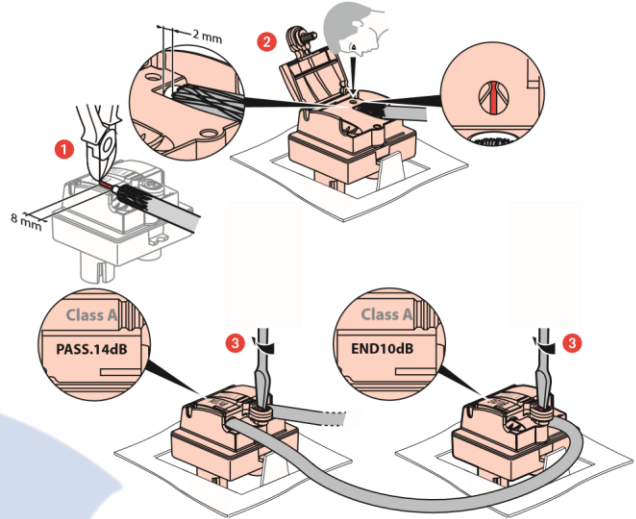

Created : 28/06/2016
 Cat. Nos : 7 645 57/58/64/65 7
 646 57/58/64/65
 7 647 57/58/64/65

5. WIRING PRECAUTIONS

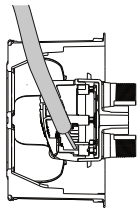
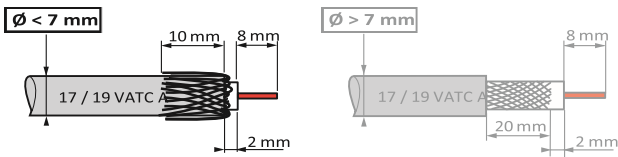

Connection from the rear of the socket reduces deformation of the coaxial cable, thus avoiding the risk of impedance loss and impaired performance.

6. TECHNICAL CHARACTERISTICS

6.1 Mechanical characteristics

- Protection against solid bodies and liquids: IP 21
- Protection against impact: IK 04
- Cable strength 120 N: IEC 61169-24

6.2 Material characteristics

- Material:**
- Cover plate: ABS
 - Zero halogen
 - UV resistant
- Motor:**
- Casing: Zamac
 - Cover: Zamac
 - Pin: Bronze
 - Screws: Zinc-plated steel

6.3 Electrical characteristics

- Male connector \varnothing 9.52 mm (TV)
- Female connector (radio)
- Female F screw-type connector (SAT)
- Characteristic impedance: 75 ohm

Class A shielding efficiency (class A shielding is necessary to prevent interference from 3G and 4G phone signals, as these undesirable signals can cause pixellation of on-screen images or distort soundtracks)

- Frequency bands:
- TV: 5-68/120-862 MHz
 - R: 87.5-108 MHz
 - SAT: 950-2400 MHz

- Insulation resistance: IEC 61169-24

6.4 Climate characteristics

Storage and operating temperature: -5 °C to +35 °C

7. CLEANING

Clean the surface with a cloth.
Do not use acetone, tar-removing cleaning agents or trichloroethylene.

Resistant to the following products: hexane (EN 60669-1), methylated spirit, soapy water, diluted ammonia, bleach diluted to 10%, window-cleaning products, pre-impregnated wipes.

Caution: Always test before using special cleaning products.

8. STANDARDS AND APPROVALS

- EN 50083-2
- Class A certificate

TV/R/SAT

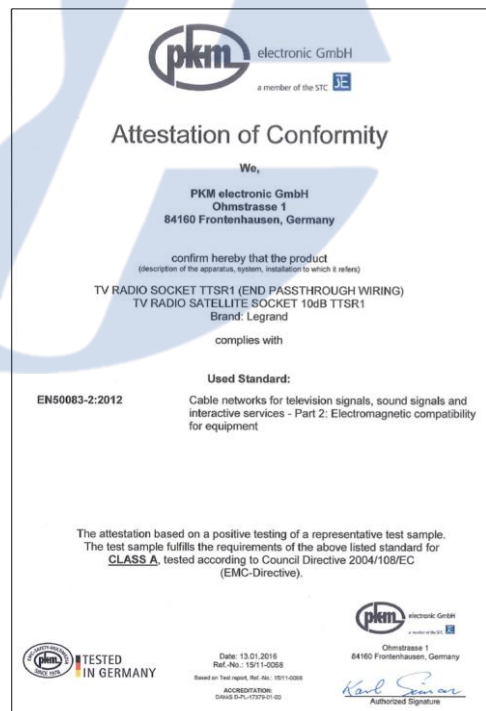
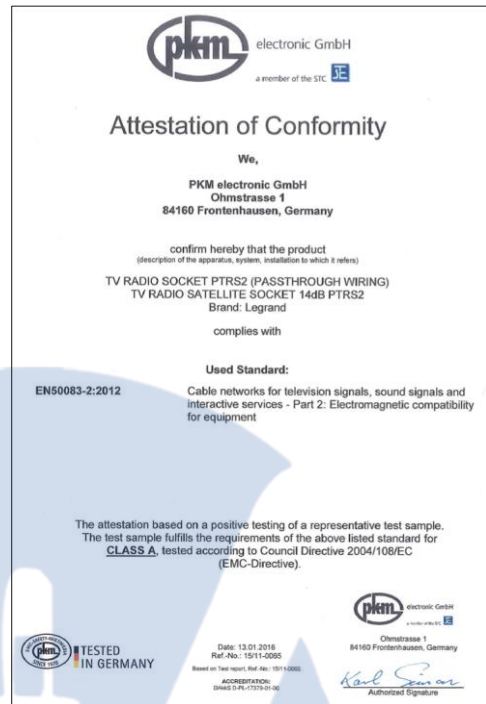

Niloe™

TV/SAT - TV/R/SAT passthrough and terminal sockets

Cat. Nos : 7 645 57/58/64/65 7
646 57/58/64/65
7 647 57/58/64/65

STANDARDS AND APPROVALS (suite)

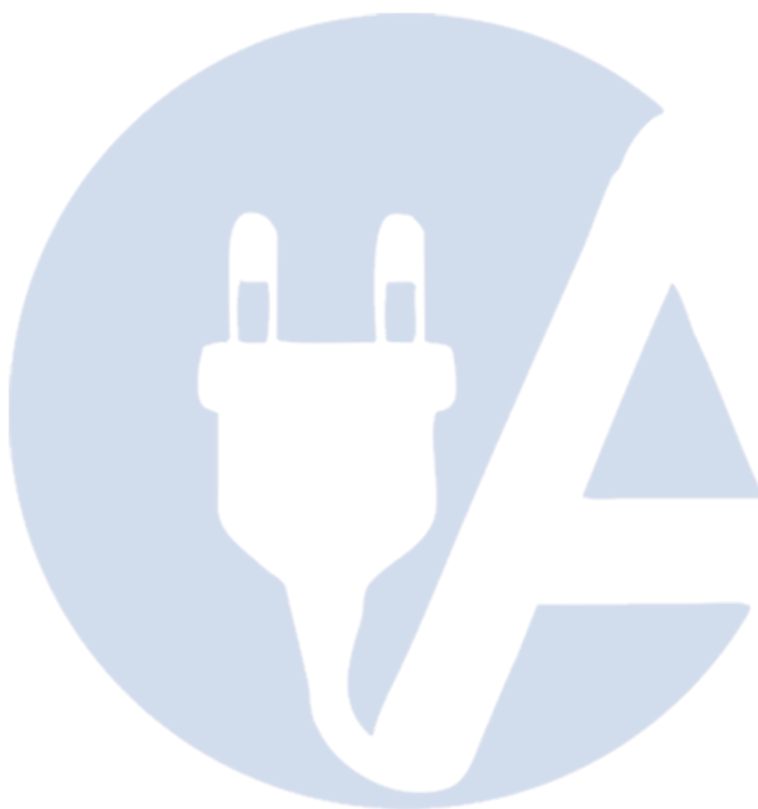

9. PERFORMANCE

TV/R/SAT

pkm electronic GmbH
a member of the STC

Attestation of Conformity

We,
PKM electronic GmbH
Ohmstrasse 1
84160 Frontenhausen, Germany

confirm hereby that the product
(description of the apparatus, system, installation to which it refers)
TV SAT SOCKET PTS2 (PASSTHROUGH WIRING)
TV SATELLITE SOCKET 14dB PTS2
Brand: Legrand

complies with

Used Standard:
EN50083-2:2012 Cable networks for television signals, sound signals and interactive services - Part 2: Electromagnetic compatibility for equipment

The attestation based on a positive testing of a representative test sample.
The test sample fulfills the requirements of the above listed standard for **CLASS A**, tested according to Council Directive 2004/108/EC (EMC-Directive).

TESTED IN GERMANY

Date: 13.01.2016
Ref. No.: 15/11-0096
ACCREDITATION: DAAS D-PL-17279-01-00

pkm electronic GmbH
Ohmstrasse 1
84160 Frontenhausen, Germany
Karl Seiser
Authorized Signature

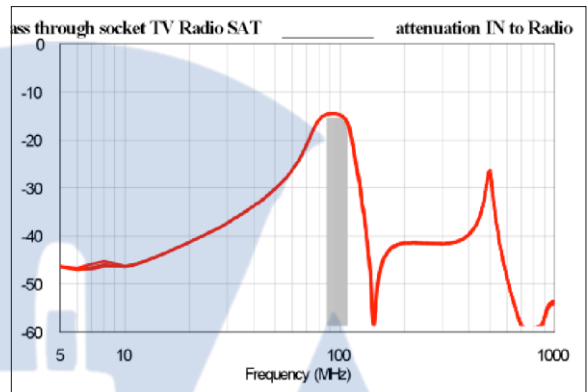
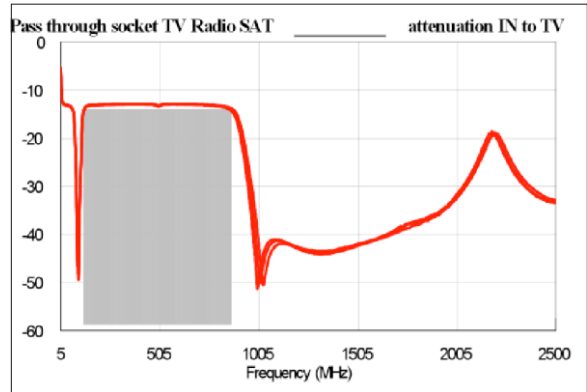

pkm electronic GmbH
a member of the STC

Attestation of Conformity

We,
PKM electronic GmbH
Ohmstrasse 1
84160 Frontenhausen, Germany

confirm hereby that the product
(description of the apparatus, system, installation to which it refers)
TV SAT SOCKET TTS1 (END PASSTHROUGH WIRING)
TV SATELLITE SOCKET 10dB TTS1
Brand: Legrand

complies with

Used Standard:
EN50083-2:2012 Cable networks for television signals, sound signals and interactive services - Part 2: Electromagnetic compatibility for equipment

The attestation based on a positive testing of a representative test sample.
The test sample fulfills the requirements of the above listed standard for **CLASS A**, tested according to Council Directive 2004/108/EC (EMC-Directive).

TESTED IN GERMANY

Date: 13.01.2016
Ref. No.: 15/11-0209
ACCREDITATION: DAAS D-PL-17279-01-00

pkm electronic GmbH
Ohmstrasse 1
84160 Frontenhausen, Germany
Karl Seiser
Authorized Signature

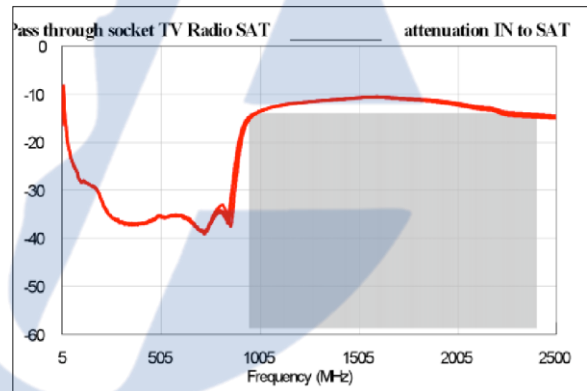

Niloe™

TV/SAT - TV/R/SAT passthrough and terminal sockets

SOMMAIRE

Cat. Nos : 7 645 57/58/64/65
7 646 57/58/64/65

PERFORMANCE

